

UNIVERSAL SPEAKERS

BS-1110W Full Range Speaker System



BS-1120W 2-Way Speaker System



DESCRIPTION

Developed under the concept of "Universal" use, TOA's BS-1110W and BS-1120W are column speakers (with speakers arrayed in a vertical line), which makes it possible to create unique sound spaces featuring a wide horizontal spread of sound that remains tightly focused in the vertical plane. Their simple, tasteful design harmonizes well with virtually any building interior, making them a perfect choice for use in such gathering places as religious facilities and school auditoriums.

The BS-1110W's narrow enclosure features two 12cm dynamic cone speakers rated for an input of 10W. The BS-1120W features four built-in 12cm dynamic cone speakers and a 2.5cm balanced tweeter to cover a wide frequency range of 150 – 20,000Hz for clear and powerful sound reproduction (20W rated input and 1W/1m sound pressure level of 93dB).

The speakers' rear panel-mounted rotary switches permit selection of line voltage, impedance (HIGH/LOW) and wattage (BS-1110W: 5/10W; BS-1120W: 10/20W). Handy push-in connectors are used for the speaker line input terminals to facilitate wiring and permit cascade system configurations. Rated power output can also be increased by inter-connecting the BS-1110W with the BS-1120W.

The BS-1110W and BS-1120W can be mounted directly to wall surfaces without the need of extra mounting hardware, and their supplied or optionally available mounting hardware can be used to mount them to either walls or ceilings. Their supplied mounting hardware permits the speakers to be mounted either vertically or horizontally to change the speaker coverage area or meet the spatial requirements of their intended use and type of installation.

The BS-1110W, in particular, can be mounted directly to wall surfaces, either vertically or horizontally, without requiring special mounting hardware (or using its optional mounting hardware), facilitating use in a wider range of applications. The BS-1110W also transports easily for convenient touring PA applications when used in conjunction with the optional ST-16 Speaker Stand and mobile amplifiers.

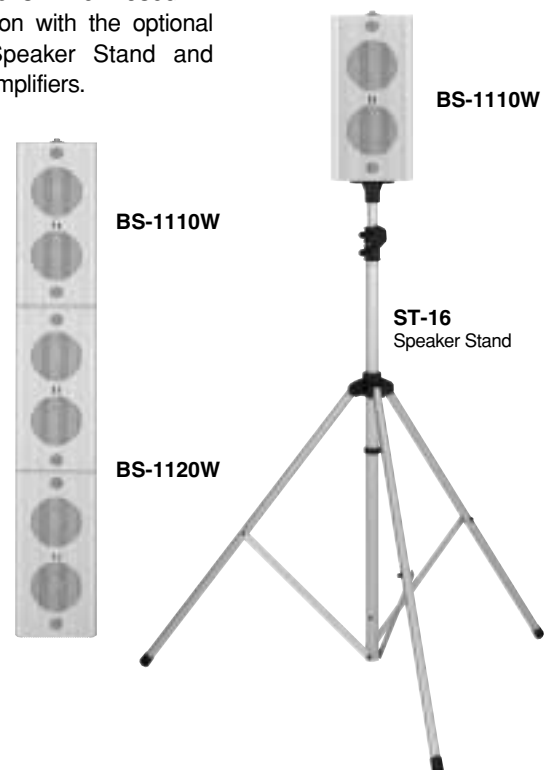

www.amthanhtoav.vn



Frequency Response

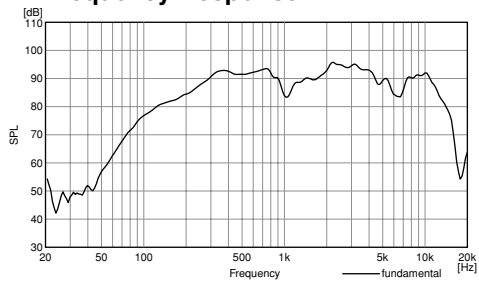

Beamwidth vs. Frequency

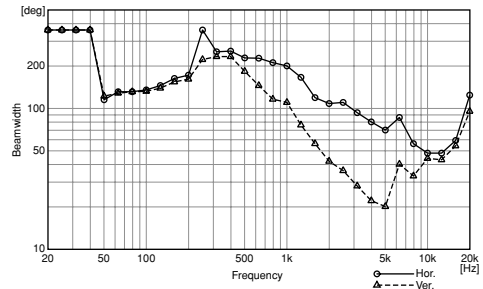

Directivity Factor vs. Frequency

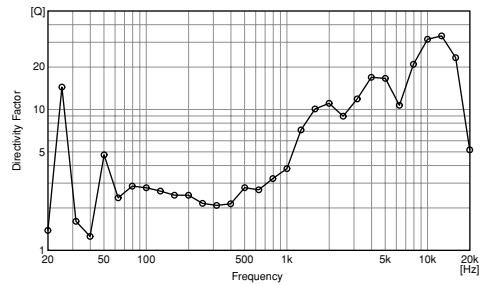

Polar Response

horizontal

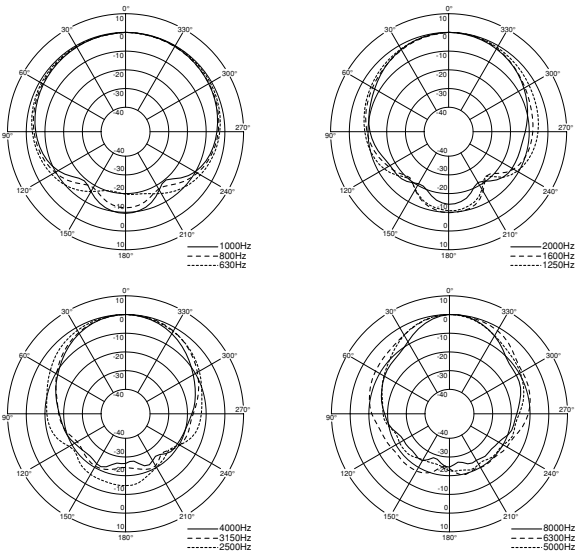

vertical

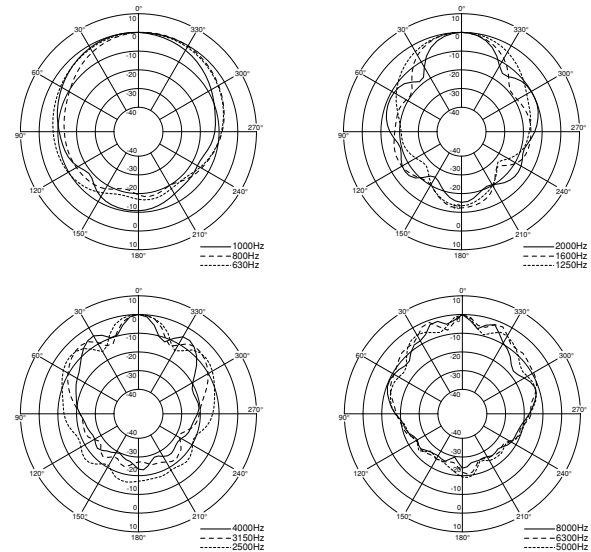

APPEARANCE AND DIMENSIONAL DIAGRAM

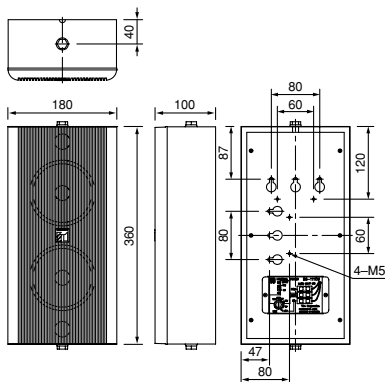

Mounting bracket (accessory)

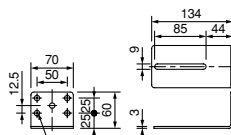

Fixing Hole (1/2)



Unit: mm

Wiring Diagram

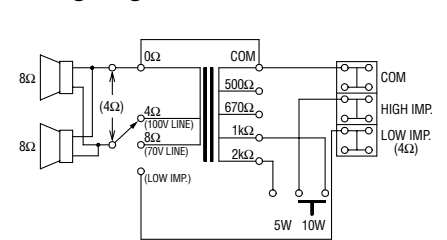

(Factory-preset wiring)

BS-1120W

CHARACTERISTIC DIAGRAMS

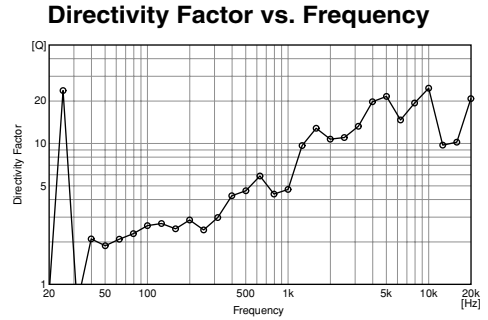
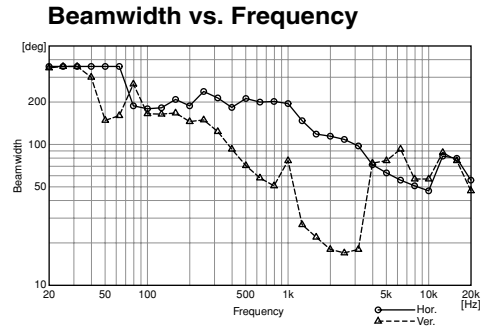
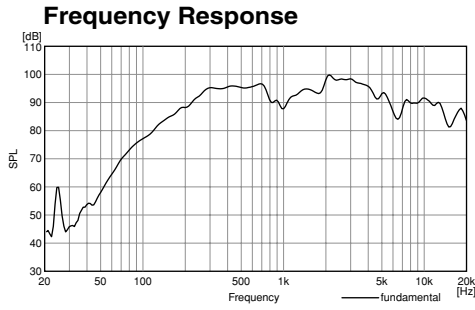

Polar Response

horizontal

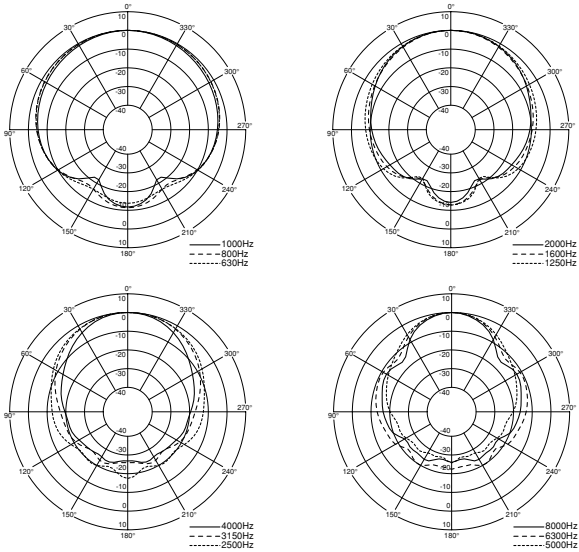

vertical

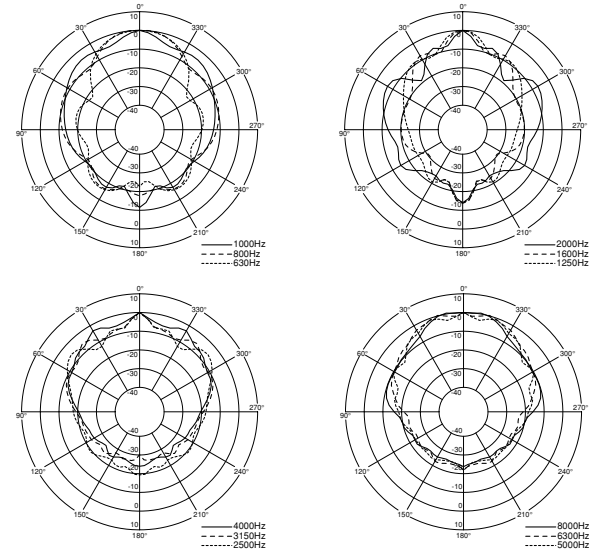

APPEARANCE AND DIMENSIONAL DIAGRAM

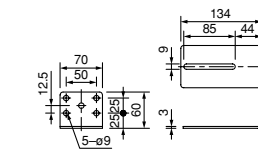
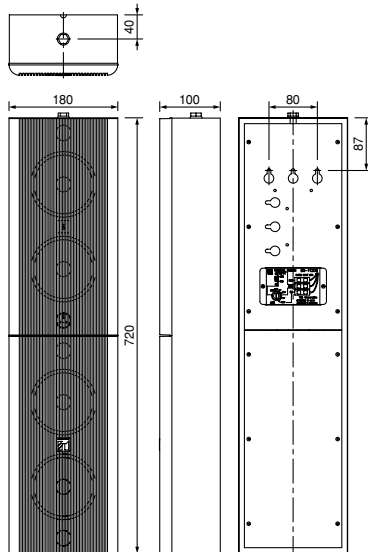

Mounting bracket (accessory)

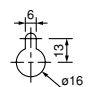

Fixing Hole (1/2)

Unit: mm

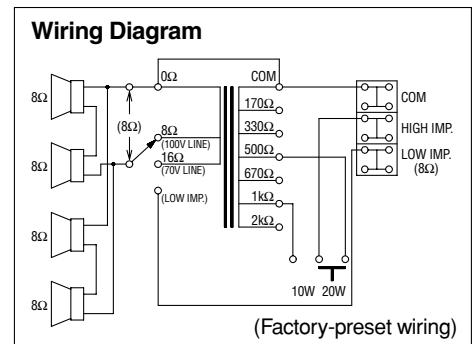

SPECIFICATIONS

	BS-1110W	BS-1120W
Rated Input	10W	20W
Rated Impedance	100V LINE: 1k Ω (10W), 2k Ω (5W) 70V LINE: 500 Ω (10W), 1k Ω (5W), 4 Ω (10W)	100V LINE: 500 Ω (20W), 1k Ω (10W) 70V LINE: 250 Ω (20W), 500 Ω (10W), 8 Ω (20W)
Sensitivity	90dB (1W/1m)	93dB (1W/1m)
Frequency Response	150 – 14,000Hz	150 – 20,000Hz
Speaker Component	12cm dynamic cone-type speaker x 2	12cm dynamic cone-type speaker x 4 Balanced dom tweeter x 1
Applicable Cables	600V Vinyl-insulated cable (IV wire or HIV wire) Solid copper wire: ϕ 0.8 – ϕ 1.2mm 7-core twisted copper wire: 0.75 – 1.25mm ²	
Connection	Push-in connector (Bridging connections possible.)	
Operating Temperature	-10°C to +50°C	
Finish	Enclosure: Plywood vinyl coating, white (RAL 9010 PURE WHITE) Front: ABS resin, white (RAL9010 PURE WHITE) Rear: Steel plate, white (RAL9010 PURE WHITE)	
Dimensions	180 (W) x 360 (H) x 100 (D) mm	180 (W) x 720 (H) x 106 (D) mm
Weight	2.9kg (unit only)	5.1kg (unit only)
Accessory	Mounting bracket x 2	
Option	Applicable bracket: YS-301, SP-410, WCB-12W, TMB-1W Applicable stand: ST-16	Applicable bracket: YS-301

OPTIONS

YS-301
In-Wall/Ceiling
Mounting Bracket



TMB-1/TMB-1W
Table Mounting Bracket



SP-410
Wall/Ceiling
Mounting
Bracket

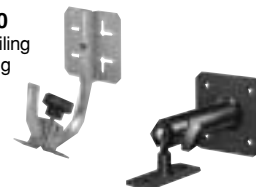

WCB-12/WCB-12W
Wall/Ceiling Mounting
Bracket



ST-16
Speaker Stand

INSTALLATION EXAMPLES

BS-1110W			BS-1120W	
<ul style="list-style-type: none"> • Direct 	<p>YS-301 In-Wall/Ceiling Mounting Bracket</p>	<p>WCB-12/WCB-12W Wall/Ceiling Mounting Bracket</p>	<ul style="list-style-type: none"> • Direct 	<ul style="list-style-type: none"> • With Supplement Bracket
<ul style="list-style-type: none"> • With Supplement Bracket 	<p>SP-410 Wall/Ceiling Mounting Bracket</p>	<p>TMB-1/TMB-1W Table Mounting Bracket</p>	<p>ST-16 Speaker Stand</p>	